



# Tour Owner's Manual



## Table of Contents

<b>Introduction</b> .....	<b>2</b>	<b>Accessories</b> .....	<b>20 - 23</b>
<b>Summary of Set-Up &amp; Fold-Down</b> .....	<b>2</b>	<b>Flexion Distraction &amp; Lateral Flexion</b> ...	<b>24</b>
<b>Identification of Parts</b> .....	<b>3 - 6</b>	<b>Elevating Conversion Base</b> .....	<b>25</b>
<b>Table Set-Up</b> .....	<b>7 - 11</b>	<b>Care &amp; Maintenance</b> .....	<b>26 - 27</b>
<b>Heapiece Operation</b> .....	<b>11 - 14</b>	<b>Warranty</b> .....	<b>27</b>
<b>Table Operation</b> .....	<b>14 - 17</b>	<b>Overview of Products</b> .....	<b>Back</b>
<b>Table Fold-Down</b> .....	<b>18 - 19</b>		

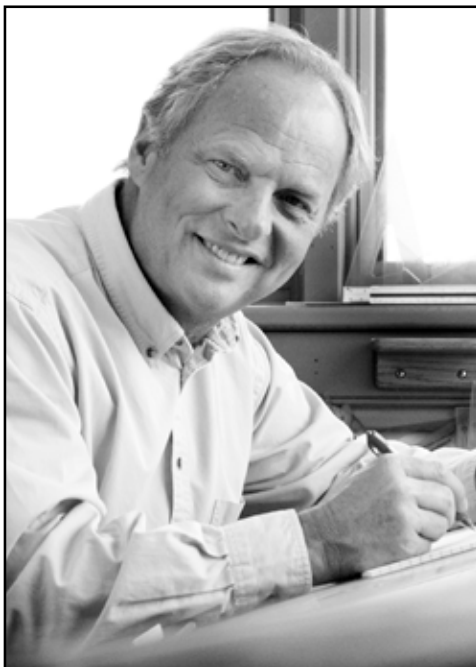

Thank you for your purchase of a Tour portable table.

We are pleased to provide you with a chiropractic adjusting table that is elegant, versatile and engineered with precision. It has been thoroughly inspected and tested right down to the smallest detail before leaving our shop. We are confident that it will provide you with many years of reliable service.

Please take the time to read this manual. It will familiarize you with the table and instruct you on its proper operation and maintenance.

If you have any questions or comments, please contact us.

Sincerely,

A handwritten signature in cursive script that reads "Rick Thuli".

**Rick Thuli, D.C.**  
**President**

## Table Set-Up & Fold-Down: Quick Reference

**Set-Up:** Begin at the headpiece and progress toward the ankle rest (pgs 7-9).

1. Open the table (pg 7)
2. Remove headpiece from storage, engage T-bar and attach headpiece (pgs 7-8)
3. Erect front legs (pg 8)
4. Attach piston to headpiece (pg 8)
5. Release thoracic section (pg 9)
6. Erect middle legs & attach support braces (pg 9)
7. Erect back legs (pg 9)

**Fold-Down:** Reverse the set-up sequence above (pgs 18-19). Begin at the ankle rest and progress toward the headpiece. Fold the front half of the table onto to the back half.

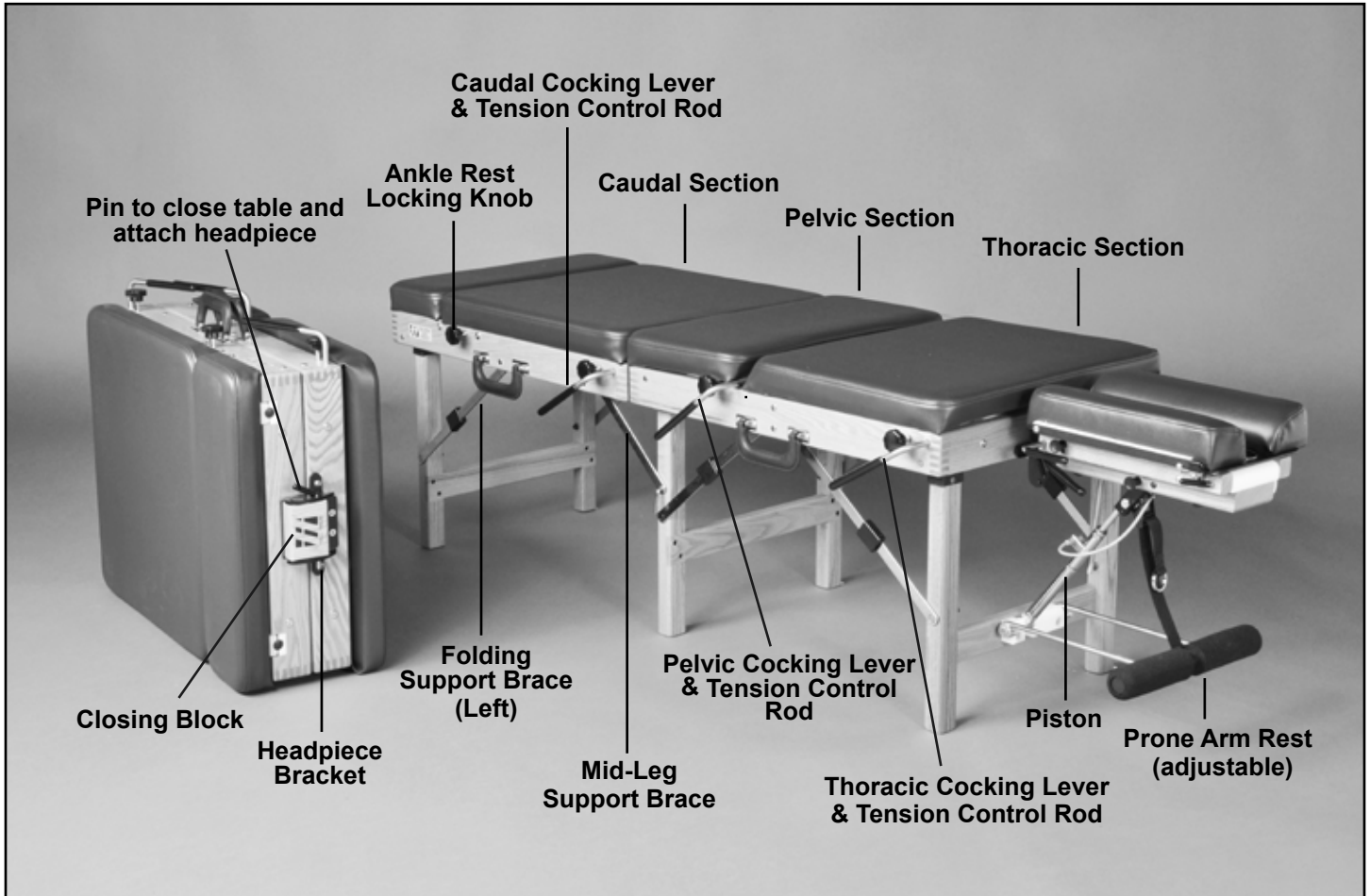

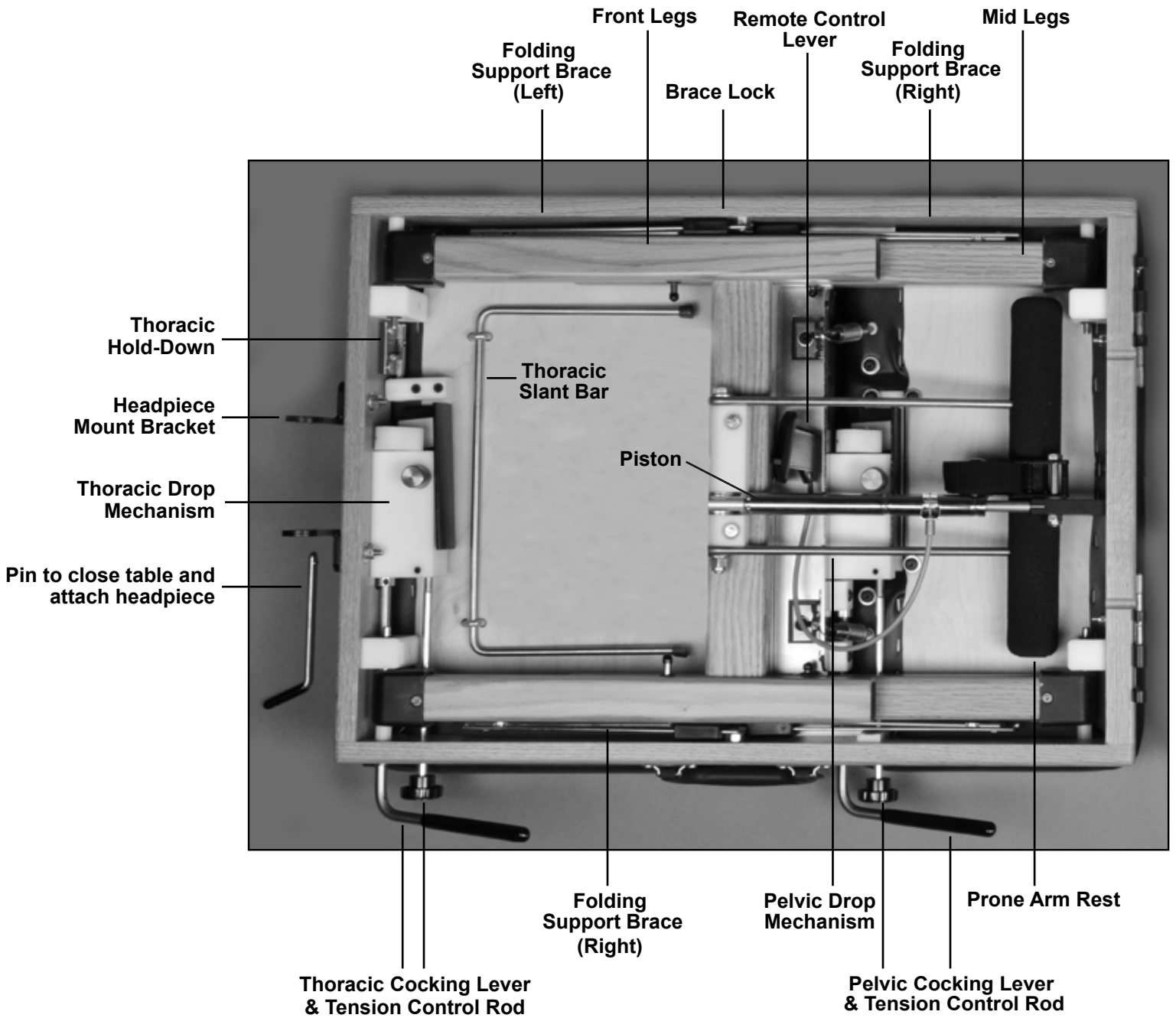

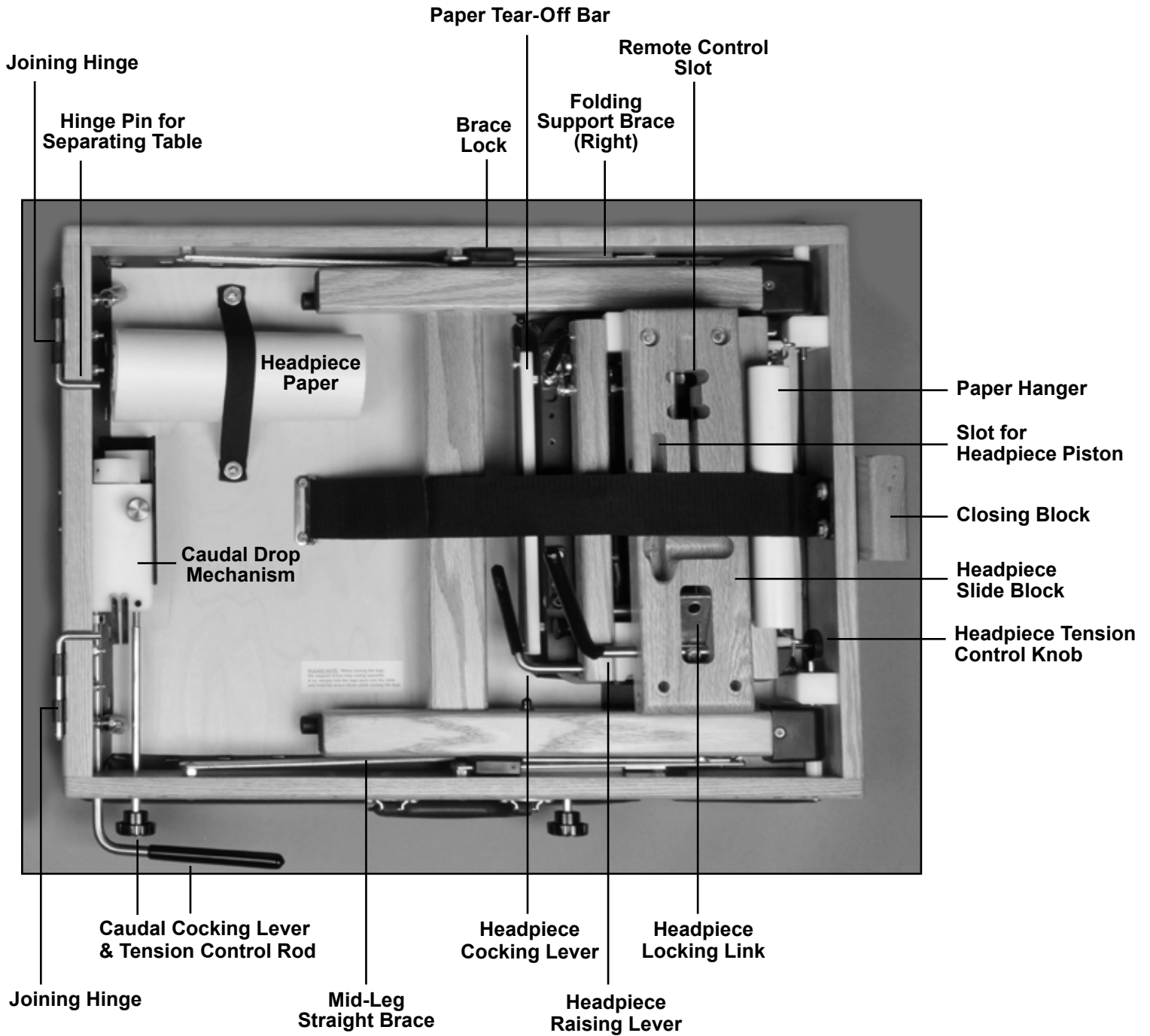

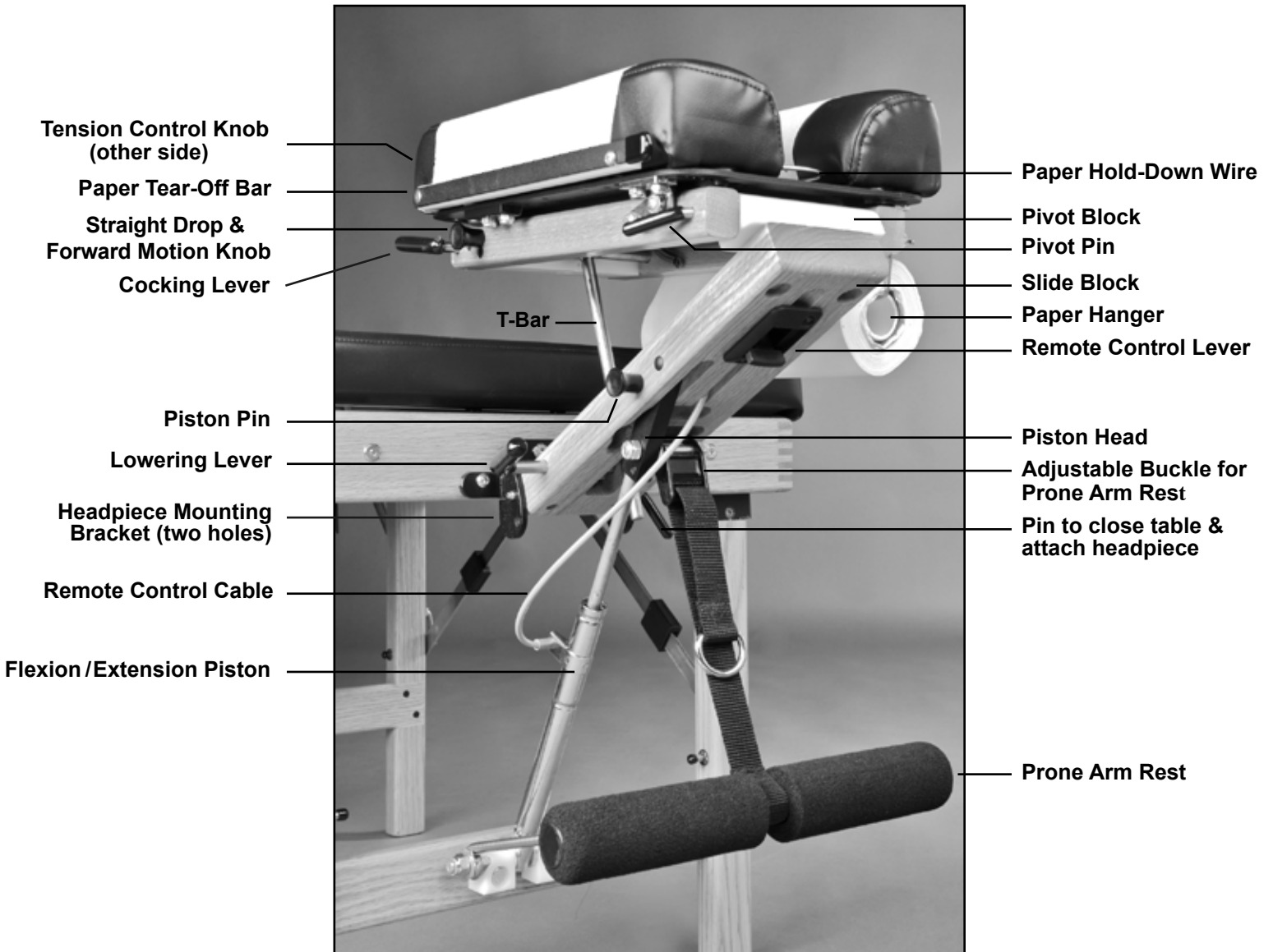

## OPEN THE TABLE

1. Position yourself on the handle side of the table. Lay the table onto its cushions so that the Thuli logo is upside down.
2. Remove the pin from the metal bracket. Open the table by grasping one of the carrying handles.
3. Set the pin on the floor at the left end of the table. You will use this pin to attach the headpiece.

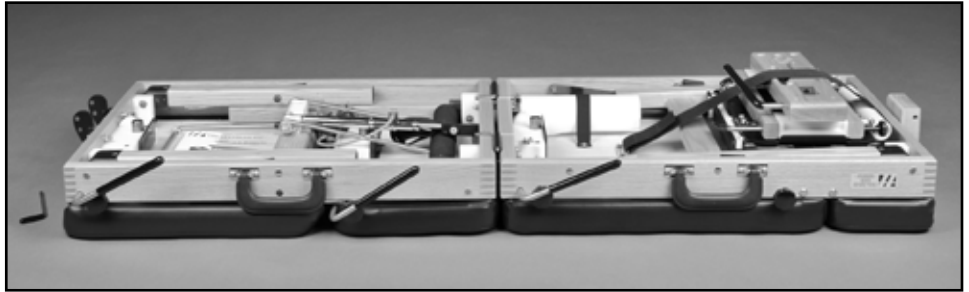

**Begin at the headpiece end and progress toward the ankle rest:**

## HEADPIECE ATTACHMENT



1. Unfasten the Velcro strap and remove the headpiece from its storage position and place on its cushions.  
**Note:** The strap is not included on Tours with Flexion Distraction.
2. Lift the slide block by grasping the lowering lever and raising it to a 45 degree angle.
3. Grasp the end of the T-bar with your other hand. Insert it into the hole in the locking link of the slide block.
4. Lower the slide block to a closed position by applying counter clockwise (downward) torque to the lowering lever.

## HEADPIECE ATTACHMENT (continued)

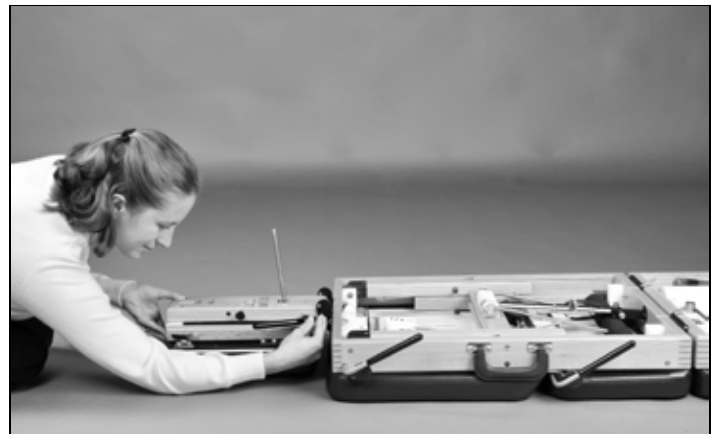

5. To attach the headpiece to the table, line up the hole of the slide block with the hole of the mounting bracket **closest** to the cushions. Insert the pin with a twisting motion.  
**Note:** If you are using the Comfort Pillow, the slide block will come with a plastic attachment. Line it up with the holes of the mounting bracket **farthest** from the cushions. Insert the pin with a twisting motion.

## HEADPIECE ATTACHMENT (continued)



6. Before raising the front legs from their folded position, disengage the piston head from its locked position. Squeeze the remote control lever and retract the piston head from the hole in the frame.

## FRONT LEG SET-UP (continued)



3. Straighten the folding leg support braces and lock them into place by sliding the black brace locks over the brace joints. **Note: If the brace lock falls down off of the brace joint,** slide the lock back over the joint and exert a slight pressure perpendicular to the brace at the brace lock. This will provide sufficient friction to keep the brace lock in place.

## FRONT LEG SET-UP



2. Raise the front legs from their folded position by grasping the horizontal crosspiece.

## PISTON ATTACHMENT (continued)

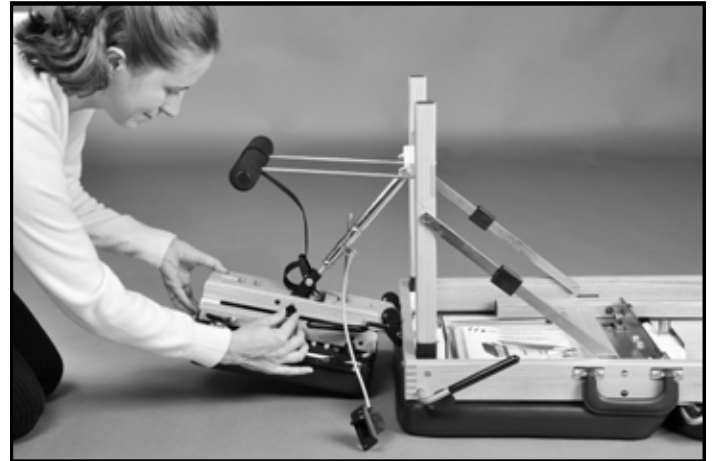

4. Swing the headpiece flexion/extension piston down toward the off-centered slot in the slide block.
5. Remove the piston pin from the slide block and raise the front end of the headpiece to allow the piston to engage in the off-centered slot. **Note: Operating the remote control lever** will allow you to rotate the piston head to align with the off-centered slot.
6. Attach the flexion/extension piston to the slide block by visually lining up the holes and re-inserting the piston pin.



## REMOTE CONTROL LEVER

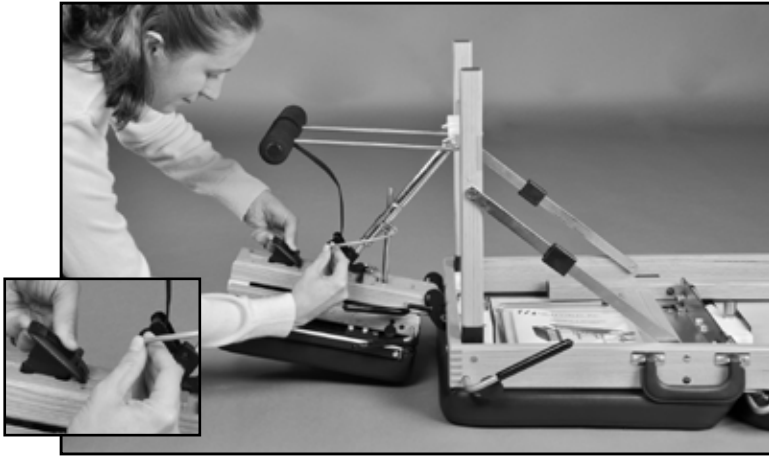

1. Install the black remote control lever into the bottom of the slide block by inserting the cable into the narrow slot and tilt the cable end of the lever into the slot until it snaps into place. Note the milled finger recess for later removal of this lever when folding up the table. Operating this lever will allow the headpiece to lay flush with the table cushions.

## THORACIC RELEASE & MID-LEG SET-UP

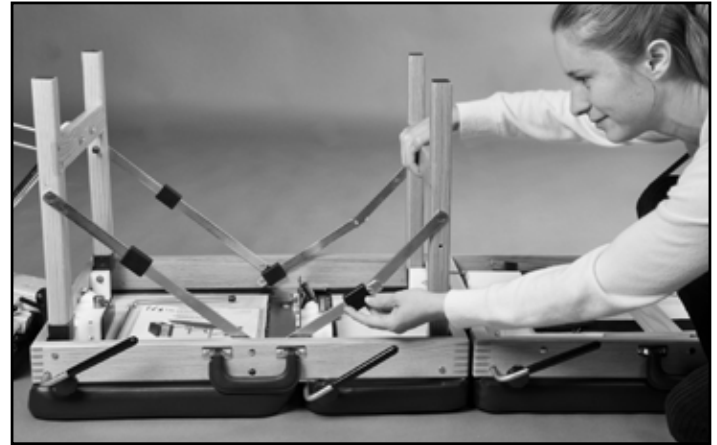

2. Release the Velcro-secured thoracic section.
3. Raise the middle legs by grasping the horizontal crosspiece.
4. Before the brace joints are fully straightened, slide the black brace locks up toward the brace joints, then straighten the braces and lock them into place. This step prevents the brace locks from becoming bound between the middle and front leg brace joints and is necessary only when setting up the middle legs.

## MID-LEG STRAIGHT BRACES

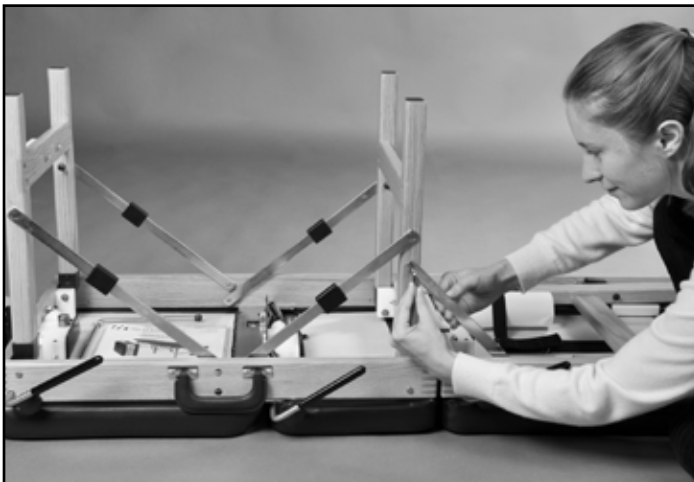

- Swing the two mid-leg straight braces up from the back section of the table and attach them to the middle legs:** Line up the hole in the brace with the brass insert in the middle leg. Push the mid-leg pin through the brace from the inside of the leg until the ball (on the end of the pin) is completely engaged through the brace.

## BACK LEG SET-UP

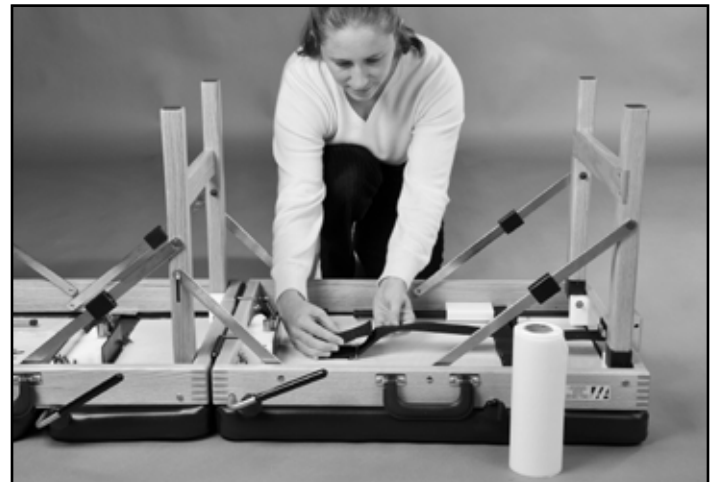

1. Raise the back legs and lock the brace joints into place in the same fashion as the front and mid-legs.
2. Reattach the Velcro strap through its metal loop.
3. Remove the headpiece paper from storage under the elastic strap.

## GAS SPRING & CONTROL LEVER REMOVAL



Remove the Abdominal Swing-Away gas spring and control lever from its storage location. Note that the control lever is positioned and attached by a magnetic latch.

## GAS SPRING INSTALLATION



Slide the black control lever housing onto the front folding leg support brace and position it to come into contact with the black poly lock. It will be held in place with an internal magnet.

## GAS SPRING INSTALLATION (continued)



Insert the base end mount of the black gas spring in to the slot in the aluminum mount block which is attached to the cross brace of the front legs. Do this by pulling outward on the white handled spring pin, inserting the gas spring base end tab and then releasing the white handled spring pin until it engages in the tab.

## GAS SPRING INSTALLATION (continued)

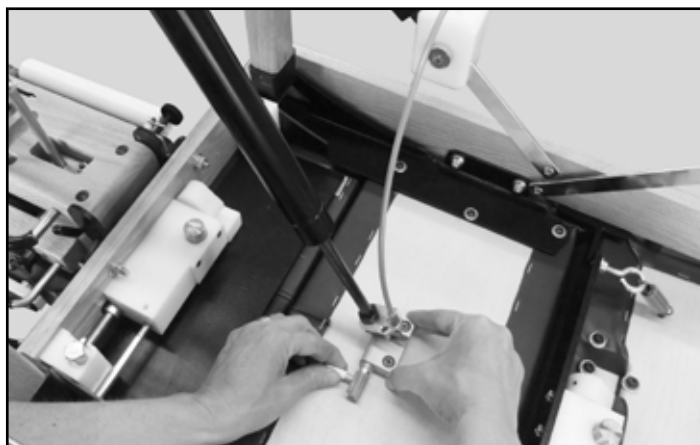

Repeat previous step on the operating end of the black gas spring where it attaches to the abdominal cushion. You may need to pull up or push down slightly on the abdominal cushion by grasping the aluminum mount block to help with alignment so that the engaging spring pin slides in easily.

## CORRECT TABLE POSITIONING BEFORE SETTING UPRIGHT

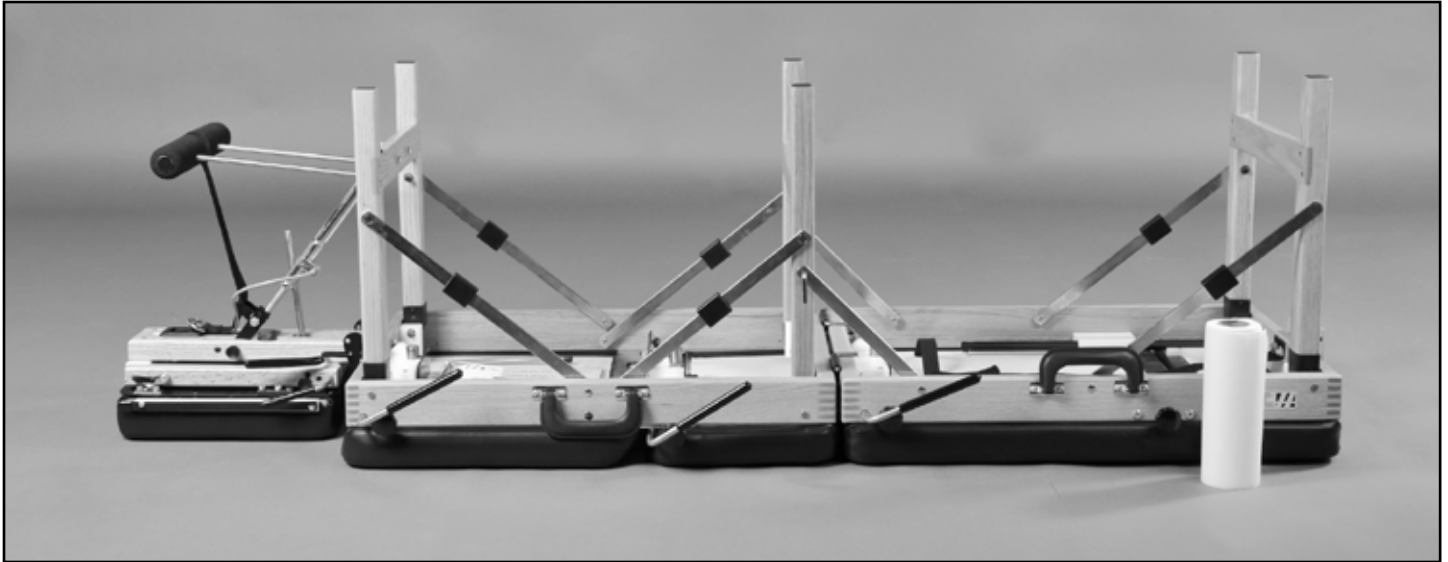

**SET THE TABLE UPRIGHT:** Tilt the table away from you and onto its feet.

## HEADPIECE PAPER



1. Install a 8.5" roll of headpiece paper.
2. Raise the paper hold-down wire and tear-off bar. Advance the paper and tuck it between the cushions.
3. Lower the hold-down wire between the cushions, lower the tear-off bar and tear off excess paper. See step 5.
4. To advance the headpiece paper, raise the tear-off bar, hold your finger on the paper hold-down wire and pull the paper across the cushions. Pulling the paper in an upward direction will reduce friction making it easier to pull.
5. To tear off used headpiece paper, use an upward motion while holding down the tear-off bar.

## FLEXION AND EXTENSION

Flex and extend the headpiece by grasping the front end of the headpiece and operating the remote control lever on the underside of the headpiece with your fingertips.



## VERTICAL ELEVATION



1. Raise the back end of the headpiece by lifting the red grip of the cocking lever (without operating the lever).  
**Caution:** Do not grasp the cushions to raise the back end, which could stretch and damage the small springs.



2. Raise the front end of the headpiece by operating the remote control lever.



3. With practice, steps 1 and 2 can be combined to vertically raise the headpiece in one smooth motion.

## VERTICAL LOWERING



1. Lower the front end of the headpiece by operating the remote control lever, as in flexing or extending the headpiece.



2. In one smooth motion, lower the back end of the headpiece by lifting the headpiece lowering lever firmly with one hand while gently lowering the back end of the headpiece with the other.

## HEADPIECE PORTABILITY



The Tour headpiece can easily be detached and used as a portable headpiece for cervical adjusting. Simply lift the back end of the headpiece until the T-bar disengages from the locking link. Snap the T-bar into the receiver clip on the underside of the headpiece for storage. Remove the pivot pin from the front of the headpiece. Place the headpiece on a stable surface. You can use the straight drop and forward motion drops. Please note that it will not raise up/down or flex/extend when not mounted to the table.

**Note:** A stabilization base for the portable headpiece is available from Thuli Tables to distribute the drop forces over a broader surface.

## HEADPIECE CUSHION ADJUSTABILITY

The headpiece cushions are adjustable in width for patient comfort. Firmly pull up on the front end of each headpiece cushion and move in (one or two notches) or out (one or two notches) to the desired position. Secure cushions by engaging locating pins into notches provided.



Neutral position.



Narrower position for smaller faces (eg children).



Wider position takes pressure off of the patient's eyes.

## STRAIGHT DROP



**PRIOR to cocking the headpiece**, set for straight drop by pulling out the headpiece straight drop/forward motion knob until you feel it is “set” into position. This will be just short of coming into contact with the cocking bar. If you pull the knob out too far, simply push it back in.

Cock the headpiece with an upward motion on the headpiece cocking lever.

Set the desired tension by turning the tension control knob clockwise (increasing tension) or counterclockwise (decreasing tension).

## DROP OPERATION AND TENSION SETTING

The drops on the headpiece and table have adjustable tension and cock with an upward movement of the cocking lever. Following is a general guideline for setting the tension.

1. Advise your patient prior to setting the tension.
2. With the patient on the table, cock the drop section with an upward motion of the cocking lever. There must be sufficient tension on the drop to hold the patient's head or body weight.
3. Decrease the tension control knob by turning it counter-clockwise until the section drops.
4. Increase the tension by turning the tension control knob clockwise 3-4 half turns. As a general rule, the drop is now set for the patient's weight, which may vary according to the practitioner's preference.

## FORWARD MOTION DROP

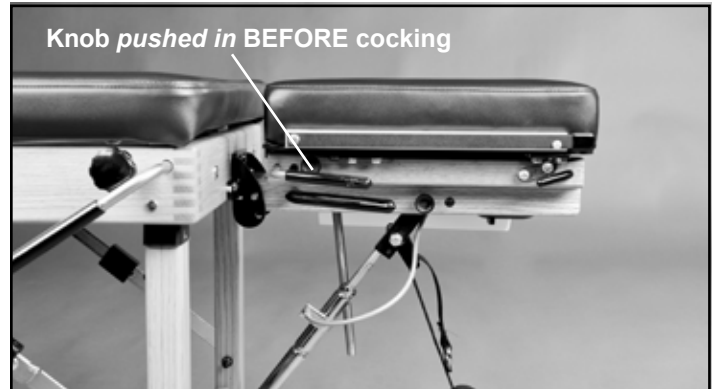

**PRIOR to cocking the headpiece**, set for forward motion drop by pushing in the headpiece straight drop/forward motion knob.

**Please note:** Be sure to change the headpiece drop function **before** cocking the headpiece to prevent an ineffective drop and damage to the drop mechanism.

## MAXIMIZING FACIAL COMFORT

For patients sensitive to pressure on the eyes, slightly raise the back end of the headpiece. This will take pressure off of the eyes, supporting the weight of the head at the mandible and zygomatic arches. This maneuver, in combination with slight flexing of the headpiece, will provide optimal facial comfort for some patients.

## THORACIC SLANT SECTION

Release the thoracic section by unfastening the Velcro.  
Swing down the metal slant bar and engage the ends into the holes in the leg blocks.



Cervical palpation and adjusting.



Anterior thoracic adjusting.



## THORACIC DROP & ADJUSTABLE PRONE ARM REST

**Note:** Release the thoracic section prior to raising or using the drop.

**When using the thoracic drop, the patient should be positioned sufficiently forward with arms outstretched and wrists supported by the adjustable Prone Arm Rest.** This will insure that the patient's arm will not be pinched between the thoracic section and the table frame.

## PELVIC DROP

Proper prone positioning on the pelvic drop section should have the patient's anterior superior iliac spine (ASIS) at the juncture of the pelvic and thoracic sections.

## CAUDAL DROP



Use of the caudal drop section for supine adjusting of the pelvis when used in conjunction with the raised thoracic slant section.

## SIDE POSTURE POSITIONING



Side posture support of the patient's head for lumbo-pelvic adjusting or toggle recoil adjusting. Shown with Headpiece Extension Pillow.

## ANKLE REST EXTENSION

The ankle rest can be extended up to 8" and locked into position by tightening the tension knob on the side of the table. Shorter patients can drop their feet into the recess created by the extended ankle rest.



## ABDOMINAL SWING-AWAY



Activate the lever on the side of the table while depressing the abdominal section. This can be done before the patient lays on the table or while the patient is on the table. Adjust the position of the swing-away section to the patient's comfort.

## POSITIONING



The Abdominal Swing-Away offers prone comfort to pregnant patients or to those with "a little extra around the middle."

## INTERCHANGEABLE CHEST CUSHIONS: FIRM & SOFT

The firm chest cushion has a foam density that matches the firmness of the rest of the table and is ideal for thoracic drop adjusting. The soft chest cushion has a combination of soft foam in the breast area (for comfort) and firmer foam surrounding for adjusting.

## PLACEMENT OF CHEST CUSHION



The chest cushions are attached by four magnets. To remove the cushion, simply grasp at both sides and twist (toward the headpiece) with a lifting motion. The cushion is held in correct position by aligning the two holes on the underside of the chest cushion with the two nickel-plated acorn nuts on the thoracic drop plate.

## CHEST CUSHION USES



Additional uses for the chest cushion include:

1. To fill the space vacated by the extended ankle rest (photo).
2. As a bolster under the patient's ankles when prone.
3. As a bolster under the patient's knees when supine.

## WHEN FOLDING THE TABLE, REVERSE THE SEQUENCE OF TABLE SET-UP. BEGIN AT THE ANKLE REST AND PROGRESS TOWARD THE HEADPIECE.

1. Return the ankle rest extension, drop sections and headpiece to their neutral positions and remove the headpiece paper roll from the paper holder. Reattach the paper roll holder to the headpiece.
2. Turn the table upside down onto its cushions. Stand on the side opposite the carrying handles and cocking levers, and tip the table toward you onto its side, then onto its cushions. You will now be able to proceed with folding the table for transport, working from the carrying handle/cocking bar side of the table. **See page 19 for the Abdominal Swing-Away fold-down.**
3. Fold the back legs down into the table. Be sure to slide the black brace locks completely down to where the braces are riveted to the table frame.
4. Push in the mid-leg pins to disengage the mid-leg straight braces, swing the braces into the back section of the table and then **push the mid-leg pins completely in** until they are flush with the leg, allowing for clearance when folding up the middle legs.
5. Fold the middle legs into the table in the same manner as for the back legs.
6. Secure the thoracic section in place with the Velcro closure.

## HEADPIECE DETACHMENT & STORAGE

7. Remove the remote control lever, utilizing the finger slot provided.
8. Remove the headpiece piston pin from the side of the headpiece to disconnect the flexion/extension piston from the slide block.
9. Retract the piston rod completely into its cylinder by operating the remote control lever with one hand while pushing the rod in with the other. (see photo)
10. Store the headpiece piston pin in the hole from which it was removed.
11. Fold the front legs into their storage position.
12. Swing the prone arm rest, along with the piston, all the way into the table, tucking the remote lever with attached cable under the two metal bars of the prone arm rest. Engage piston into hole in frame.
13. Detach the headpiece from the table by removing the closing/mounting pin with a twisting motion and set it on the floor. You will use this pin to secure the two table halves together when folded.
14. Slide the headpiece out from between the headpiece mounting bracket.
15. Disengage the T-bar from the slide block by holding the headpiece side rail down with one hand while lifting the slide block with the other. Store the shaft of the T-bar in the clip on the inside headpiece strap. Fold the slide block of the headpiece back down over the T-bar.



## HEADPIECE STORAGE

16. Unfasten the black Velcro strap located in the back section of the table. **Note:** Strap is not included on Tours with Flexion Distraction.
17. **Store the headpiece, cushions down, into the UPPER RIGHT HAND CORNER of the back section of the table** and secure into place with the Velcro strap. The headpiece paper holder may remain in place attached to the headpiece, laying on top of the side rail.
18. Store the headpiece paper roll under the elastic strap located to the left of the stored headpiece.

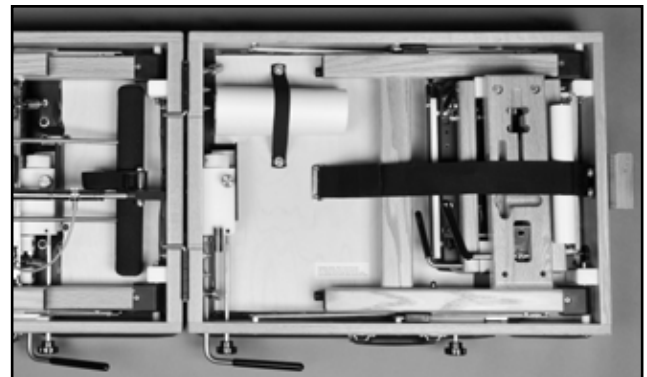

## ABDOMINAL SWING-AWAY FOLD-DOWN (optional feature)

**After Step 2 on page 18:** Detatch and store the gas spring and control lever in the reverse sequence that you used in set-up.

**NOTE:** The “operating end” of the gas spring must be positioned with the cable attachment/lever apparatus pointing upward (see photo 1, page 10). The black cylinder of the gas spring should be snapped into the spring clamps and positioned to remove all slack from the gray cable sheath. Attention to this positioning will allow the two cushions of the headpiece to straddle the apparatus when it is stored.

## CLOSING THE TABLE

- 1. Fold the front section (i.e. the section without the stored headpiece) onto the back section of the table.** This will prevent the headpiece from shifting out of position during table closure. Make certain that the carrying handles do not obstruct closure. The spring-loaded headpiece lowering lever will be oriented somewhat upward in its properly stored position and will automatically collapse when closing the table. This is normal.

NEVER USE FORCE to close the table or to fold down any of the table's components, as this may indicate improper positioning of internal parts.

### Checklist to insure unobstructed table closure:

- Carrying handle of front section must clear carrying handle of back section when closing table.
  - Flexion/extension piston must be completely in the hole of the table frame.
  - Black leg support brace locks must be pushed down all the way to where the braces are riveted to the frame.
  - The headpiece must be stored in the upper right hand corner of the back section of the table.
- 2. Secure the two table halves together by inserting the pin through the Thuli closing block and the headpiece mount bracket with a twisting motion.**
  - 3. Set the table upright onto its four protective bumpers which offer protection to the vinyl when the table is folded for transport.**



## SIDE ARM RESTS



The Side Arm Rests provide an 8"-14" wider table surface in the thoracic region for supporting the patient's arms whether prone or supine. To install, slide the two rods of the Side Arm Rests into the pre-drilled holes in the table frame. The Side Arm Rests must be removed before folding up the table or when using the pelvic and/or thoracic drop sections. They must be ordered at the time of original table purchase and can not be added at a later time.

**CAUTION:** Remove the Side Arm Rests **BEFORE** the patient gets off of the table. **The weight of a person on the Side Arm Rests can result in a cracked table frame.**

## HEIGHT RAISING LEGS



The Height Raising Legs offer a second pre-determined height to the Tour, up to 30". Please note that they are not variable in height and must be removed when folding the table.

The Height Raising Legs can be added at a later time (some installation required).



## CRESCENT ARM REST

The Crescent Arm Rest provides additional forearm support in the prone position and is easily adjustable in height.

To attach, simply slide both slotted ends of the bracket onto the rivets located on the inside of the front legs and push down until it snaps into place on top of the standard Prone Arm Rest.

Can be added at anytime.

## PRONE ARM REST SHIELDS



Nonporous and durable plastic shields slip over the prone arm rest grips. Easy to sanitize.

**COMFORT PILLOW**



The base of the Comfort Pillow quickly inserts into place between the headpiece cushions. The opening is adjustable.



The Comfort Pillow offers massage quality facial comfort in the prone position.



Rotate the Comfort Pillow 180 degrees to provide cervical support in the supine position.



The velcro on the underside of the pillow secures it to the base, allowing for width adjustability.

**EXTENSION PILLOW**

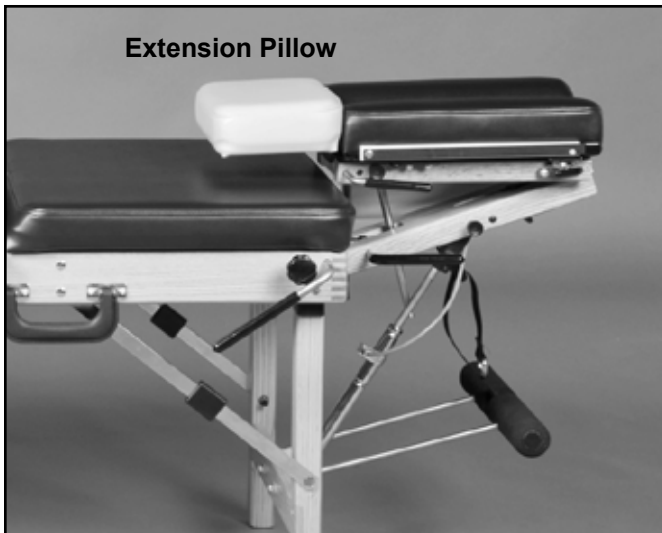

The Extension Pillow provides added supine support of the patient's head when using the caudal section during anterior pelvic adjustments. Quickly attaches to the headpiece.

**BOLSTERS**



Bolsters are 20" wide with a nonslip base. Choice of two heights: 2.75" or 4.25". Use in prone position under ankles or in supine position under knees to relax hamstrings.

**PROTECTIVE COVER**



The Protective Cover provides excellent protection when traveling by car. With the folded table in its upright position, place the cover over the top of the table. Lean the table forward and tuck the flap under the table. Lean the table back, pull the flap from under the table, and secure with velcro.

**PULL CART**



This strong, lightweight folding Pull Cart is great for transporting the Tour. With large 5" rubber wheels, it easily negotiates stairs, curbs and athletic fields. A velcroed strap secures the table to the Pull Cart. For added convenience, it can be used in conjunction with the Protective Cover or Airline Travel Case. When folded, the Pull Cart fits inside the airline overhead compartment.

**CARRYING BAG FOR ACCESSORIES**



Carrying Bags are custom-sized to fit a Crescent Arm Rest, Comfort Pillow, Height Raising Legs or Side Arm Rests. Multiple accessories may fit in one carrying bag (please inquire). Black only.

## AIRLINE TRAVEL CASE

With interior foam padding, the airline Travel Case offers protection for the Tour during airline travel and are easy to load. Available in Lightweight or Heavy-Duty versions. The top and bottom caps are the same on both versions, but the sleeves are made of different materials (as described below).

**Lightweight Travel Case:** Features a corrugated plastic (Coroplast) sleeve. With the Tour inside, the total weight is just under 70 lbs, which avoids a potential airline baggage surcharge. Coroplast is durable, waterproof and shock absorbent. Please note that the construction tape on the sides of the case simply hide the functional heavy-duty staples which secure the sides together.

**Heavy-Duty Travel Case:** Features a durable, rigid ABS plastic sleeve and is recommended for more rugged use, ex. train or bus travel. With the Tour inside, the total weight is over 70 lbs.

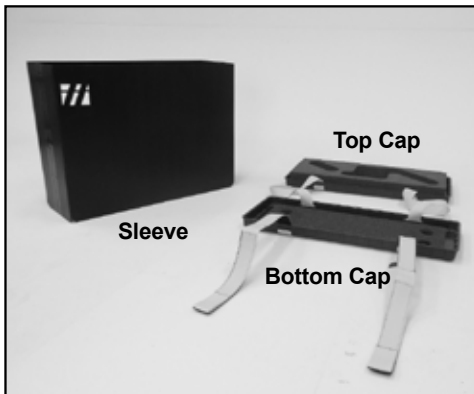

To prepare the Travel Case for loading, unbuckle the straps (but keep them attached to the top and bottom caps). Remove both the top cap and the sleeve.

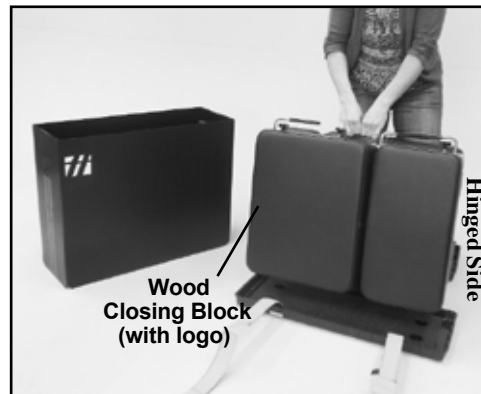

Place the Tour into the bottom cap with the correct orientation, i.e. when the top cap goes on, the logo on the Travel Case should be on the same side as the Thuli Tables wood closing block.

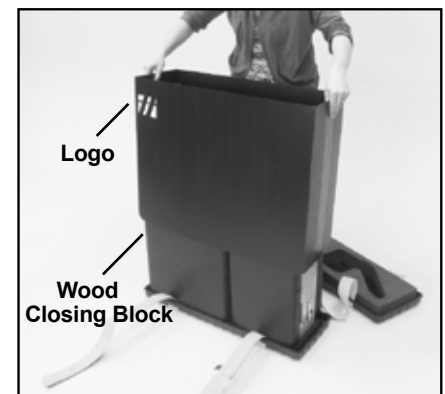

Slide the sleeve over the table so that the logo on the Travel Case is on the same side as the Thuli Tables wood closing block. Slide the sleeve snugly inside the bottom cap.



Place the top cap over the sleeve. Secure the case closed by buckling the two straps.



Lift the Travel Case by grasping the straps.



For ease of transport and navigating door openings and stairs, place the Travel Case in the vertical position onto the Pull Cart. Secure the case to the cart using the strap.

## FLEXION DISTRACTION DEVICE

Add Flexion Distraction to your Tour at anytime with this ingenious, mechanical device. Simply fold the back legs of the table into their storage position and attach the FD Device in seconds. It quickly disassembles for portability.

## LATERAL FLEXION BASE

The Lateral Flexion Base offers 30° right and 30° left flexion and can be locked in at any position. Since it must be used in conjunction with the Flexion Distraction Device, it offers compound angles as well. Speciality wheels offer quiet, smooth and instant directional change. Please note that, unlike the Flexion Distraction Device, the Lateral Flexion Base is not considered "portable".



## FLEXION DISTRACTION TRAVEL CASE



Protect the Flexion Distraction Device in this rugged and compact Travel Case during car or airline travel. Made of durable, corrugated plastic. Straps secure the case closed and serve as lifting/carrying handles.

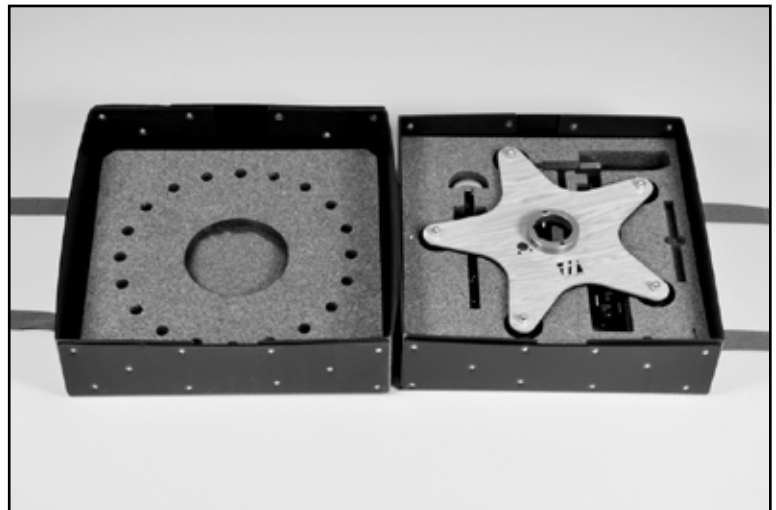

Custom die-cut, shock absorbing foam offers maximum protection of individual component parts during travel.



## TOUR CONVERSION BASE



Ingeniously converts the Tour portable table to an elevating table in minutes! Simply fold the legs inside and mount the Tour to the elevating Conversion Base using four hand-turn knobs. Detaches quickly when the need for a portable table arises. Can be added at a later time.

**Note:** The Abdominal Swing-Away, Flexion Distraction and Lateral Flexion **cannot be used** when the Tour is mounted to the Conversion Base.

## DROP MECHANISMS: CLEANING & LUBRICATION

Periodic lubrication of the drop mechanisms will ensure smooth, crisp drops. Apply **3-IN-ONE** oil every month or 500 adjustments. If the drops have not been lubricated on a regular basis, first apply **WD-40** to clean the plungers from dust & debris. See below.

### CERVICAL DROP



#### Routine lubrication:

1. Elevate the headpiece and cock the drop mechanism.
2. Apply **3-IN-ONE** oil into the hole of the plastic block.  
Allow a few minutes for the oil to penetrate before using.

#### If the drop has not been lubricated on a regular basis:

1. First apply **WD-40** into the hole and then drop the headpiece several times to clean the plunger from dust & debris.
2. It is important to follow the cleaning with **3-IN-ONE** oil for lubrication.

### TENSION CONTROL ADJUSTMENT

The resistance on the tension control rod can be increased or decreased. Do this by adjusting the set screw on the bottom of the thoracic, pelvic and caudal drop blocks using a 1/8" allen wrench:

**Increase resistance:** Turn the set screw clockwise. This is helpful if the tension control rod is "backing out" while using the drop.

**Decrease resistance:** Turn the set screw counter-clockwise.

### THORACIC, PELVIC & CAUDAL DROPS



#### Routine lubrication:

1. Place the table on its cushions.
2. Locate the stainless steel plungers.
3. Apply **3-IN-ONE** oil onto each plunger. Allow a few minutes for the oil to penetrate before setting the table upright.

#### If the drops have not been lubricated on a regular basis:

1. Lay the table on its cushions.
2. Apply **WD-40** onto the plungers and allow a few minutes for penetration. Set the table upright and drop each section several times to clean from dust & debris.
2. Set the table back on its cushions and apply **3-IN-ONE** oil onto each plunger for lubrication. Allow a few minutes for the oil to penetrate before setting the table upright. Drop each section several times.



Set Screw

## VINYL CLEANING

- 1. Mild Daily Cleaning:** Use dish soap and warm water (1:10) with a soft cloth. **Follow with a thorough, clear water rinse.** If more cleaning is necessary, use a soft bristle brush with the same solution. Avoid harsh detergents and powdered abrasives. Areas coming in contact with hair, body oils or perspiration should be washed frequently. Remove stains immediately to prevent the possibility of becoming permanent.
- 2. Disinfecting Options:**
  - Bleach:** Dilute 4 tsp bleach in 1 quart of water in a spray bottle. Spray on vinyl, leave for 1-2 minutes and rinse well with water.
  - Hydrogen Peroxide (3%):** Available in spray bottle. Use undiluted and leave on for 5 minutes and rinse well with water.
  - Alcohol (70% min):** Use undiluted. Leave on for 1-2 minutes and rinse well with water.
- 3. Water Rinse:** It is important to follow cleaning with a thorough, clear water rinse to minimize premature deterioration of the vinyl from extended exposure to chemicals.

**REPLACEMENT VINYL:** In the event of wear or damage, pre-sewn replacement vinyl is available from Thuli Tables.

## WARRANTY

Our tables are designed and built to high standards. We are proud to offer a limited lifetime warranty against manufacturing defects, with the exception of the headpiece piston and the motor (on elevation tables), which are covered by a one year warranty.

This warranty is valid to the original owner if the table has not been altered in any way. It does not cover issues caused by normal wear & tear or damage due to accidents, improper use or negligence.

If your table needs repair, whether under warranty or not, please contact us. We will determine what is needed and send you either a replacement or the necessary part for repair. Our tables have been designed so that replacing a part is relatively easy to do yourself. Please note that we do not cover labor costs if you hire someone to install the replacement part on your behalf.



**Junior Portable**



**Sport Portable**



**Tour Portable**



**300 Stationary**



**500 Stationary**



**Elevation Tables**

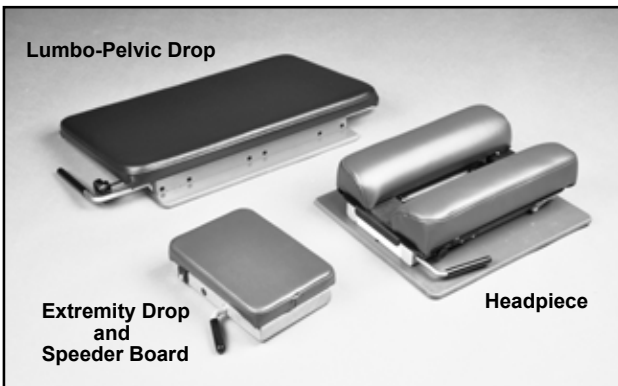

Lumbo-Pelvic Drop

Extremity Drop  
and  
Speeder Board

Headpiece

**Portable Drops**



800.458.4854

608.935.9300

[www.thulitables.com](http://www.thulitables.com)

[office@thulitables.com](mailto:office@thulitables.com)

[youtube.com/thulitables](https://www.youtube.com/thulitables)

[facebook.com/thulitables](https://www.facebook.com/thulitables)